



Technical Prospectus



Reinventing
Fire Suppression

2016



FirePro Technical Prospectus Contents

Introduction	04
Sustainable Future, Now.	06
Reinventing Fire Suppression	08
Guidance for Use & Protection Methods	09
FirePro Unit Technology	10
FirePro Benefits & Advantages	12
The FirePro Product Range	14
Modular Fire Detection & Extinguishant Controllers	16
Total Flooding Pre-Engineered System Design	17
System Layout for Room Total Flooding	18
FirePro System Installations	19
Indicative Applications	20
Certificates & Standards	22
Clients	25
Global Network	26

Introduction

At FirePro we design and manufacture modular, efficient and effective fire suppression systems which employ the patented FirePro Solid Compound at the core of their technology.



Our pre-engineered systems are designed, tested and certified according to the most stringent international standards and protocols. For over 20 years, FirePro is commissioned to safeguard key assets across a portfolio of prestigious customers, in more than 110 countries around the globe. FirePro's state of- the-art R&D division and Manufacturing facilities are Headquartered in Europe.



Sustainable Future. Now.

Fire suppression systems backed by research, committed to people and the environment.



Environmentally Conscious

The FPC solid condensed aerosol forming compound, developed after many years of R&D uses naturally occurring Potassium Salts considered to be safe both for people and the environment. Our dedication to Green and Sustainable Technologies is attested by the number and quality of International Certifications, Listings and Type Approvals.



Zero Ozone Depletion

Condensed aerosol technology for use in firefighting, gained increasing recognition as an alternative and acceptable substitute for CFCs which were banned, following the Montreal Protocol due to their negative impact on the environment and Ozone layer.

In our efforts to contribute towards humanity's sustainable development goals, we focused on Green Technologies. As a result, our products are manufactured using selective and environmentally friendly materials, that can be recycled even at the end of the product life cycle.

FirePro is considered to be ozone friendly as it contains no CFC's and is SNAP Listed (Significant New Alternative Policy) according to the EPA* (U.S. Environmental Protection Agency).

*The official EPA document, issued by the Federal Register, is available at Vol. 71, No.187/ Wednesday, September 27, 2006 / Rules and Regulations.



Zero Global Warming Potential

The FPC solid condensed aerosol forming compound does not contain any substances that contribute to global warming, such as those found in other agents e.g. fluorinated gases* used for industrial applications which are banned or are in the process of being banned according to the regulation (EU) No 517/2014 of the European parliament and of the Council, due to their negative impact on the environment.

Note: Fluorinated gases ('F-gases') are a family of man-made gases used in a range of industrial applications. Because they do not damage the atmospheric ozone layer, they are often used as substitutes for ozone-depleting substances. However, F-gases are powerful greenhouse gases, with a global warming effect of up to 23,000 times greater than carbon dioxide (CO₂), and their emissions are rising rapidly.

*Similar to ones typically found in Sulphur Hexafluoride (SF6), Hydrofluorocarbons such as HCFC, HFCs (23, 32, 41, 43-10mee, 125, 134, 134a, 152a, 143, 143a, 227ea, 236cb, 236ea, 236fa, 245ca, 365mf) and Perfluorocarbons PFCs



Green Policies

FirePro has been assessed and certified as per GEN (Global Eco-Labeling Network) Green Standard and has been granted the Green Label Certificate.



ISO 9001: 2008 and ISO 14001:2004 Certified

FirePro products are manufactured according to strict international standards and requirements regarding quality and environmental management procedures. FirePro maintains ISO 9001:2008 certification and ISO 14001:2004 certification issued by DNV GL.

Our clients can trust that FirePro is committed to actively minimize the environmental impact of its manufacturing processes, products and services, as part of our Corporate Social Responsibility.

Reinventing Fire Suppression

FirePro technology is effective and efficient as it extinguishes fire by inhibiting the chain reactions on a molecular level.

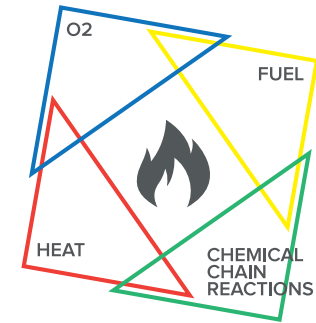

Typical fire suppression agents use one or a combination of the following methods to suppress a fire:

Fire Suppression Methods	Description of Method	Commonly used Technologies
Heat Absorption	Fire is suppressed using the indirect method of temperature reduction.	Water based & Gaseous agents
Oxygen Depletion	Fire is suppressed using the indirect method of oxygen depletion. This entails the reduction of the concentration levels of oxygen causing the suffocation of fire.	Inert gaseous agents
Chemical Inhibition	Fire is suppressed using the direct method of acting on the flame free radicals and interrupting the chemical chain reactions on a molecular level.	Condensed Aerosols

Action of FirePro Aerosol Extinguishing Agent

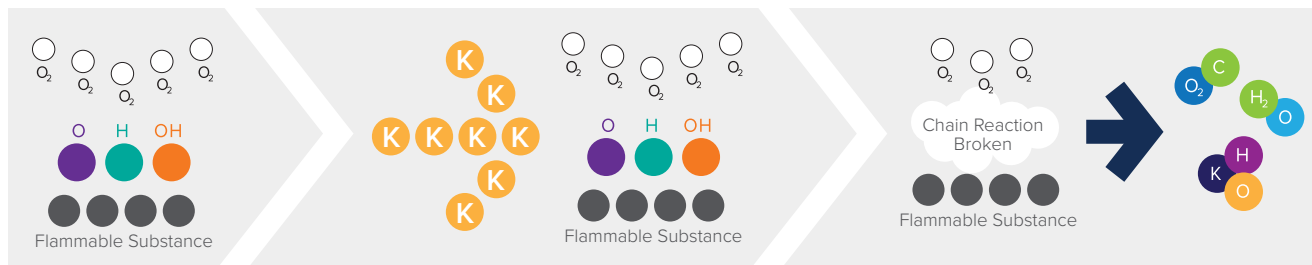

A minimum of three factors are needed for fire and they are:

- Oxygen
- A flammable substance
- An ignition temperature

Fire is nothing other than a chemical reaction in which the substances O, H and OH sustain the chain reaction.

FirePro will be activated electrically or by thermal actuation means:

The aerosol released contains potassium compounds that initiate both (A) a physical and (B) a chemical reaction with the fire.

REACTION A: PHYSICAL ACTION

A certain amount of energy is needed for the chemical reactions to take place. The required amount of energy is supplied by the abundance of energy present in the flame.

REACTION B: CHEMICAL ACTION

There are certain reactions between atoms and parts of unstable molecules (radicals), which take place in rapid succession in the flame during combustion. Unstable radicals try to become stable and undergo a number of reactions. A hydroxide (OH) is an unstable radical that also provides for the chain reaction of fire. The potassium obtained from the discharge of the potassium compounds

reacts during combustion with the free radicals of unstable hydroxides and forms potassium hydroxide (KOH), which is a very stable compound. In this phase the chain reaction of the free radicals stops and the flame goes out. KOH reacts further in the presence of CO₂ and forms again K₂CO₃.

There are also other reactions that take place during the extinguishing that ensure that the end product is not harmful to humans, environment and matter.

Guidance for Use & Protection Methods

FirePro Systems offers pre-engineered, total flooding certified solutions for class A, B, C & F fire hazards.

(according to British Standard EN-2)

DEFINITION OF TOTAL FLOODING ACCORDING TO NFPA2010:

As per section 3.3.27 of NFPA2010, a total flooding extinguishing system is a system arranged to discharge an extinguishant into an enclosure to achieve a uniform distribution of that extinguishant, at or above the design application density, throughout the enclosure volume.

SCOPE OF APPLICATIONS

I. Large Enclosures

(Any Room Irrespective of Volume)
e.g. : *Electrical rooms, Transformer rooms, Storage, Generator rooms, Archives.*

FirePro condensed aerosol fire extinguishing units, can provide fire suppression for large enclosures of any volume, due to their modular nature.

The main consideration when using FirePro units in total flooding system installations, is the dynamics of aerosol distribution.

To ensure rapid and even distribution of the aerosol in the protected volume the positioning of the units needs careful study that takes into account also the layout of and where other objects are placed in the enclosure.

II. Small Enclosures

(Electrical Panels / Cabinets)

The FirePro range includes some of the smallest autonomous and automatic fire extinguishing systems, which are used to protect, internally

small enclosures such as electrical panels or other power utilizing devices/equipment, which is often where fire initiates.

Small enclosure protection is becoming increasingly of importance in the world, due to the high sensitivity and high asset value of today's equipment. For this reason, it is imperative, that any fire occurring in such applications (small enclosures) is extinguished locally at an early stage, preventing its escalation, and restricting it from causing any further damages.

III. Manual Units

FirePro manually activated models can be used to suppress fire from a distance, quickly and effectively, especially in areas where access is restricted.

This solution is utilized mainly by fire professionals, in cases where the fire source is not possible to be reached, reducing its intensity by providing instant/partial suppression to facilitate the approach of the rescue services.

FirePro Unit Technology

EXTERNAL UNIT HOUSING

Forms the outer shell of the unit and also accommodates the activation (electrical & thermal) ports. The housing of cylindrical units is made of stainless steel for complete protection against corrosion.

Note: The box type units are produced in both stainless steel and red coated mild steel.

ACTIVATION PORTS

Each FirePro unit comes with two types of activation ports (thermal and electrical) thus providing the engineering option to utilize one or more activation device depending on application.

ELECTRICAL ACTUATOR

Upon detection of a fire the releasing panel sends an impulse of electrical energy to the electrical actuator that acts as an electric heating element to initiate the transformation of the FPC Compound into aerosol.

FPC SOLID COMPOUND

The patented solid condensed aerosol forming compound has a certified lifetime of up to 15 years and found to withstand temperatures of up to +250°C

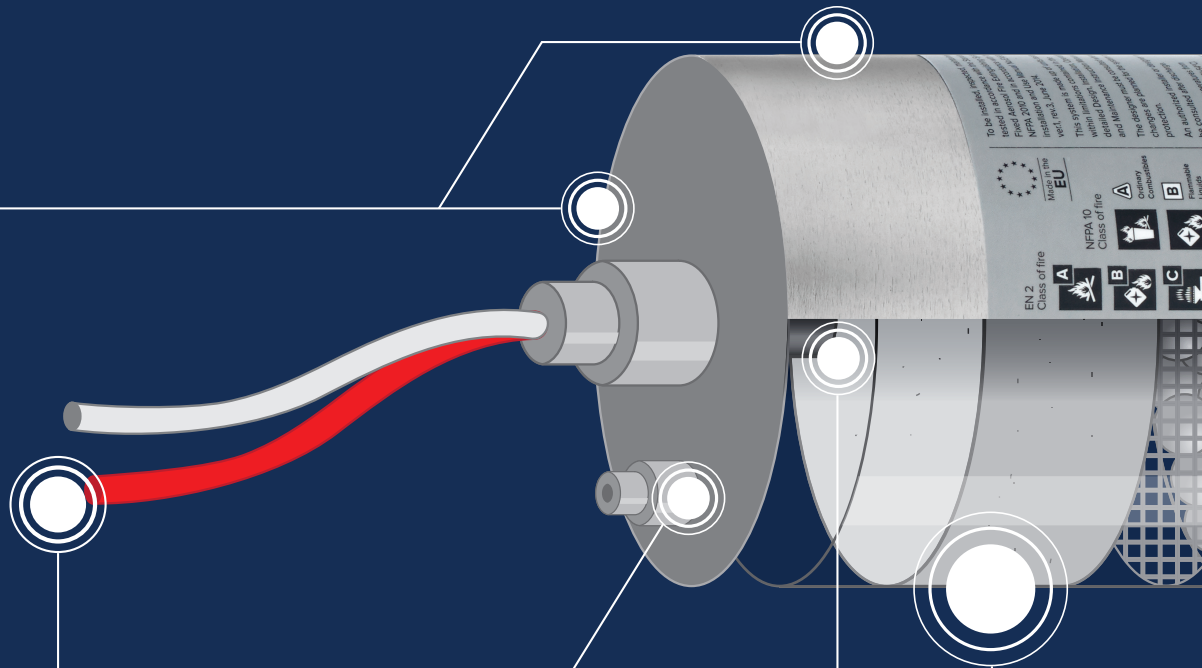

A FirePro condensed aerosol unit has a metallic casing that contains the:

- i) **FPC Solid Compound**
- ii) **Electrical Activator**
- iii) **Cooling Material**



AEROSOL

An aerosol is defined as a 2-phased media consisting of solid particles suspended in a gas. FirePro aerosol consists of Potassium based particles – active agent, suspended in a gas carrier.

NATURAL CERAMIC COOLANT

High quality alumina ceramic spheres act as both a cooling media (due to their high conductive nature) but also as a filter (any coarse aerosol particles shall be trapped within).

DISCHARGE PORT

Point from which aerosol exits the unit housing.

FirePro Benefits

FirePro systems are ideal for both conventional and non-conventional applications that were once considered by other technologies to be technically or financially challenging.



Certified 15-year shelf-life



CFC-free



Non-Oxygen Depleting



HFC-free



Halon Alternative



Zero Ozone Depletion Potential



Non-Pressurized



Zero Global Warming Potential

Advantages

FirePro offers numerous advantages to all stakeholders (designers, installers and clients) defining it as a desirable system which earns wide acceptance from both clients and engineering societies.

FOR THE DESIGNER

- **Simple in design.** Not affected by ambient conditions and other design factors.
- **Modular.** Can be easily expanded as required.
- **Fail Safe System.** Can be activated by three different modes (thermal, electrical, self-activation at 300°C).
- **Feasible to protect risks** that previously were not possible.

FOR THE INSTALLER

- **No pressure integrity tests required**
- **Simple and Fast installation**
- **No Piping**

FOR THE CLIENT

- **No Storage Space** of Cylinder Banks Required
- **No pressure test** required for components over system lifecycle
- **Up to 15 years lifetime**
- **Safe** for People and the Environment

OTHER ADVANTAGES

- Suitable to be used in environments with ambient temperature range -54°C to +100°C.
- ODP = Zero, GWP = Zero and ALT = Negligible

The FirePro Product Range

FirePro condensed aerosol units are made of the highest quality materials, certified for a shelf life of 15 years and are listed/certified by UL, ULC, BSI, KIWA and other notified Bodies.

The FirePro product range includes units of various sizes starting from the smallest 20gr unit to the largest 5700gr (gr refers to the net weight of the FPC solid compound within the unit). The units can be used either alone, in multiples or in combination to protect from fire the smallest volumes such as electrical panels (internally) to the largest volumes of warehousing, power generation plants and more (total flooding).

A unique feature of each FirePro unit is the dual mode (thermal and electrical) of activation.

FirePro units are integrated by using an advanced range of control & indicating panels and a state-of-the-art thermo bulb self-activating devices (otherwise known as stand-alone systems) that operate in the absence of electrical power.



FP20

Gross Weight (g): 310
Mass of FPC Compound (g): 20
Dimensions (mm):
Height: 165 / Ø: 22



FP40

Gross Weight (g): 610
Mass of FPC Compound (g): 40
Dimensions (mm):
Height: 140 / Ø: 51



FP80

Gross Weight (g): 870
Mass of FPC Compound (g): 80
Dimensions (mm):
Height: 185 / Ø: 51



FP100

Gross Weight (g): 1370
Mass of FPC Compound (g): 100
Dimensions (mm):
Height: 155 / Ø: 84



FP200

Gross Weight (g): 1630
Mass of FPC Compound (g): 200
Dimensions (mm):
Height: 185 / Ø: 84



FP500

Gross Weight (g): 2850
Mass of FPC Compound (g): 500
Dimensions (mm):
Height: 295 / Ø: 84

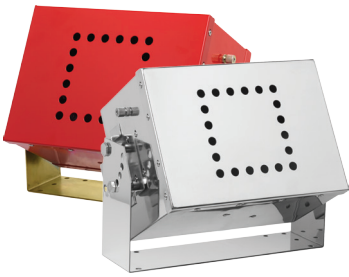

FP1200

Gross Weight (g): 10900
 Mass of FPC Compound (g): 1200
 Dimensions (mm): 216X300X167



FP2000

Gross Weight (g): 15500
 Mass of FPC Compound (g): 2000
 Dimensions (mm): 300X300X185



FP3000

Gross Weight (g): 16300
 Mass of FPC Compound (g): 3000
 Dimensions (mm): 300X300X185



FP4200

Gross Weight (g): 25000
 Mass of FPC Compound (g): 4200
 Dimensions (mm): 300X300X300



FP5700

Gross Weight (g): 26400
 Mass of FPC Compound (g): 5700
 Dimensions (mm): 300X300X300



Manual Units



FP1000M

Gross Weight (g): 2240
 Mass of FPC Compound (g): 1000
 Dimensions (mm):
 Height: 200 / Ø: 84

FP500M

Gross Weight (g): 1910
 Mass of FPC Compound (g): 500
 Dimensions (mm):
 Height: 150 / Ø: 84

FP200M

Gross Weight (g): 1800
 Mass of FPC Compound (g): 200
 Dimensions (mm):
 Height: 150 / Ø: 84

Modular Fire Protection Controllers



FPC-1

The FirePro FPC-1 Fire Protection Controller provides monitoring, detection and automatic extinguishing of a fire in an enclosure using the self contained rate of rise heat sensor or linear heat detection cable and FirePro Aerosol units.

Two outputs are provided for the connection of FirePro Aerosol units and disconnection of any of these will announce a fault condition.

Open collector contacts are available to signal fire, fault and power conditions to other monitoring equipment. The FPC-1 is powered by 4 batteries 1.5V.



FPC-2

The FirePro FPC-2 Fire Protection Controller provides monitoring, detection and automatic extinguishing of a fire in an enclosure using linear heat detection cable or automatic smoke detectors and FirePro Aerosol units.

Four outputs are provided for the connection of FirePro Aerosol units and disconnection of any of these will announce a fault condition.

Volt-free contacts are available to signal fire and fault conditions to plant or other monitoring equipment. The FPC-2 requires an external 24V DC power supply backed with batteries capable of delivering 3A.

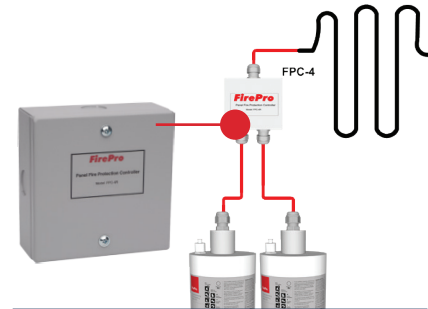

FPC-4RM

The FirePro FPC-4R Fire Protection Controller provides detection and automatic fire extinguishing in an enclosure with the use of a linear heat detector cable and up to two FirePro units.

Volt free contacts are available to signal fire conditions to plant or other monitoring equipment. The FPC-4RM powered by a 3V CR2 battery.

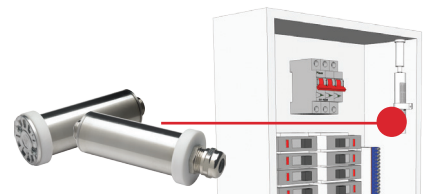

FPC-5

The FirePro FPC-5 Fire Protection Controller, attached to a FirePro unit, provides detection and automatic fire extinguishing in an enclosure with the use of a bimetallic sensor or linear heat detector cable. It is powered by a 3V CR2 battery.

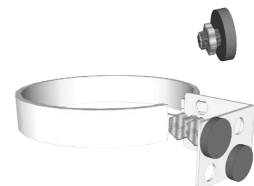

GTN-25

Magnets substitute the bolts necessary for installing/fixing the cylindrical FirePro fire extinguishing condensed aerosol units.

The GTN-25 magnet can be used with the brackets for all cylindrical models.

Bulb Thermal Actuator (BTA) - Mechanical Protection Controller

The FirePro BTA controller allows detection and automatic fire extinguishing in an enclosure with the use of a Bulb thermal sensor at a pre-selected temperature.





Total Flooding Pre-engineered System Design



Our Design Principles

The primary objective of fire protection is to safeguard human life, valued assets and the environment from the catastrophic effects of fire.

FirePro protects any enclosure irrespective of volume, and in compliance with the local fire legislation, standards and norms.

Design calculation methods are described in detail, in engineering guidelines such as NFPA 2010, ISO 15779:2011, CEN/TR 15276 and IMO Circular MSC.1/Circ.1270.

A FirePro total flooding system design, includes the following parameters:

- The class of the fire hazard.
- The potential sources of fire within the zone.
- The enclosure volume.
- The internal layout and content of zone.
- Possible openings of the enclosure.



Proper Positioning of the System Units

As a result of the design parameters, the total mass of FirePro FPC solid compound required for total flooding is calculated, using specially designed software. Based on this, the type and number of FirePro units and other system components are selected to create a fully integrated solution (see page 18).

It is at the discretion and experience of the designer to position the FirePro generators in such a manner to achieve the most efficient total flooding action (always complying with FirePro guidelines as described in the User Manuals).

Maintenance

Periodic maintenance of FirePro systems performed by certified and qualified personnel, is relatively simple and time/cost effective. This process does not include any cost intensive procedures (e.g. hydrostatic tests or agent refilling) commonly required by other conventional fire suppression systems.

Note: All installations, maintenance and replacement of discharged units is carried out by authorized personnel only.

Typical System Layout for Room Total Flooding

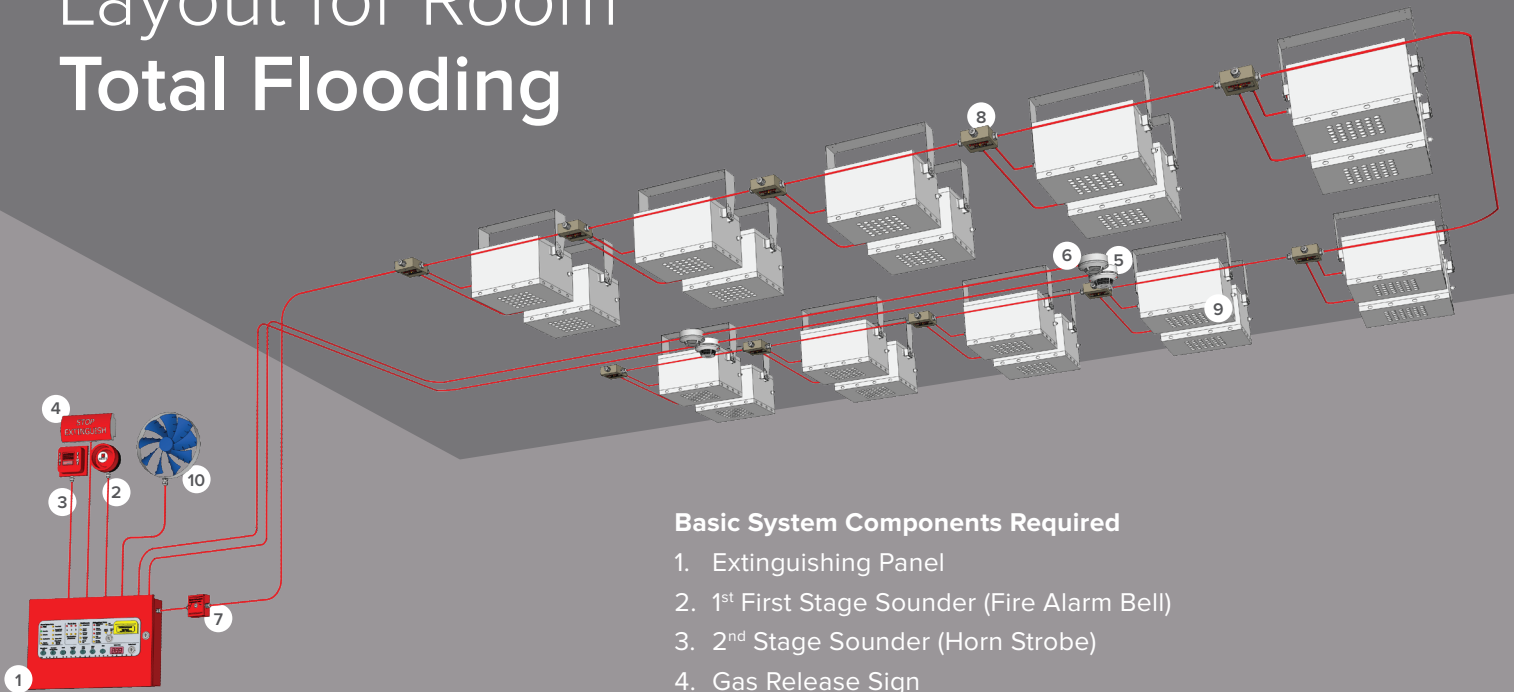

Basic System Components Required

1. Extinguishing Panel
2. 1st First Stage Sounder (Fire Alarm Bell)
3. 2nd Stage Sounder (Horn Strobe)
4. Gas Release Sign
5. Zone 1, Smoke Detector
6. Zone 2, Heat Detector
7. System Isolation Switch
8. Sequential Activator
9. FirePro Unit
10. Connection port to shut off extractor fan or close fire dampers

Note:

- I. FirePro offers system components according to the application (both for Land or Marine environments) in compliance with the local and international regulations, standards and norms.
- II. Please refer to our product catalogue available online, for the complete list of FirePro system components.
- III. FirePro extinguishant control panels, can be integrated with the most commonly used addressable fire detection systems, broadly available in the international market.

Designing a FirePro total flooding system is simple and according to the formula illustrated below:

$$m(g) = V(m^3) * d_a (g/m^3) * f_a$$

$$m(g) = V(m^3) * EAD (g/m^3) * SF * f_a$$

$m(g)$ Agent mass

$V(m^3)$ Protected volume

$d_a (g/m^3)$ Design application density

$d_a (g/m^3)$ EAD * SF

EAD (g/m³) Extinguishing application density

SF Safety factor (30%)=1.3

f_a Additional design factors

THE ABOVE DESIGN FORMULAS ARE ACCORDING TO NFPA2010 STANDARD.

FirePro System Installations

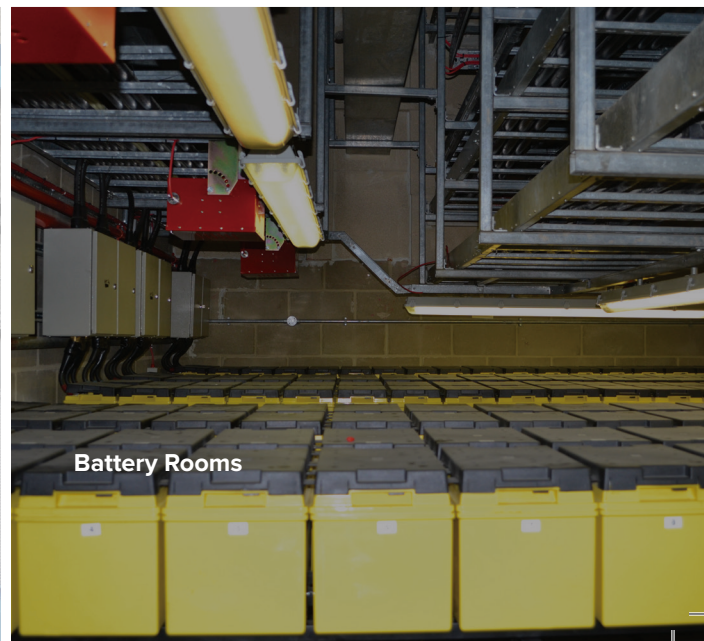
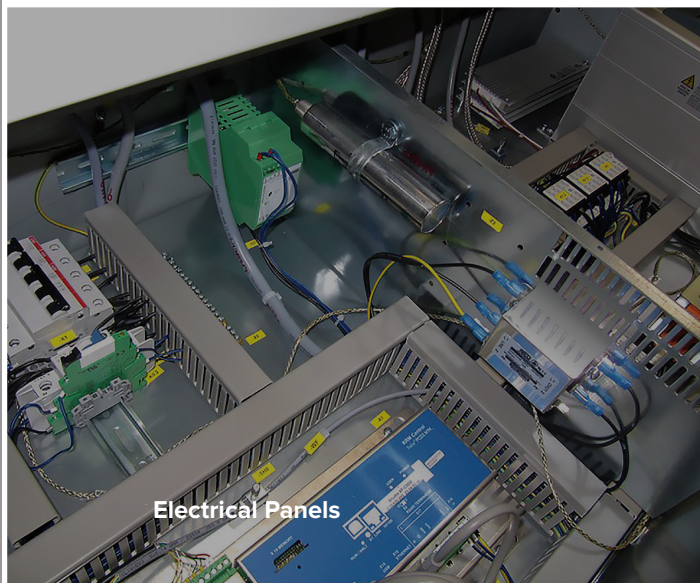

Indicative Applications

FirePro Condensed Aerosol Systems are used in the fire engineering field as a substitute for traditional gaseous type agents or in applications where pressurized storage systems were not feasible or economically viable.



Flammable
Material
Storage

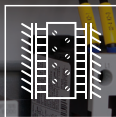

Electrical
Panels

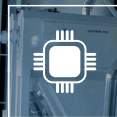

Processing
Plant



Monuments &
Historical Buildings



Transformer
Rooms





Archives /
Storage



Control
Rooms



Vehicle
Engine Bays



Marine Vessel
Engine Bays



Power Generation
Rooms



Telecom



Cable Risers
& Ducts

Certificates & Standards

FirePro holds the highest number of certificates, approvals and test reports compared to other condensed aerosol fire extinguishing technologies.

Condensed Aerosol Technology Standards:



Organization
International Organization
for Standardization
Standard
ISO 15779:2011



Organization
International Maritime
Organization
Standard
IMO: MSC.1/Circ.1270



Organization
European Committee
for Standardization
Standard
CEN/TR 15276



Organization
National Fire Protection
Association
Standard
NFPA 2010



Organization
UL - Underwriters
Laboratories INC.
Standard
UL 2775



Organization
KIWA NV
Standard
BRL-K23001/04



Organization
Standards Australia
Standard
AS 4487-2013



Organization
GOST - Russian
Quality Standards
Standard
GOST R 51046-97
Fire Engineering
Generators of
extinguishing aerosol



Organization
KFI - Korea
Fire Institute
Standard
Guideline for the
Automatic
Condensed Aerosol
Fire Extinguisher

FirePro technology Listings & Approvals:

FOR LAND APPLICATIONS:



Organization
UL - Underwriters
Laboratories
Certification Protocol
UL 2775 - Fixed
Condensed Aerosol
Extinguishing Units
Reference
FWSA.EX6960



Organization
ULC - Underwriters
Laboratories
of Canada
Certification Protocol
ULC/ORD-C2775-12 Fixed
Condensed Aerosol
Extinguishing Units
Reference
FWSAC.EX6960



Organization
BSI - British Standards
Institution
Certification Protocol
BRL-K23001/04 Aerosol
Generating Fire
Extinguishing System
Units
Reference
Kitemark License
Number KM 547633



Organization
KIWA NV
Certification Protocol
BRL-K23001/04 Aerosol
Generating Fire
Extinguishing System
Units
Reference
Product Certificate
K21774/16



Organization
CSIRO - Commonwealth
Scientific & Industrial
Research
Certification Protocol
AS 4487-2013 & UL 2775
Fixed Condensed Aero-
sol Extinguishing Units
Reference
ActivFire Certificate of
Conformity afp-2286



Organization
CNBOP PIB - Scientific
& Research Center for
Fire Protection
Certification Protocol
CEN/TR 15276-1:2009
Condensed Aerosol
Fire Extinguishing
Systems
Reference
Certificate of Conformity
NR. 4/2015



Organization
KFI - Korea Fire Institute
Certification Protocol
Guideline for the
Automatic
Condensed Aerosol
Fire Extinguisher
Reference
Sogong 15-23-1



Organization
GOST - Russian
Quality Standards
Certification Protocol
GOST R 51046-97 Fire
Engineering
Generators of
extinguishing aerosol
Reference
GOST TP 1389534



Organization
Global Mark
Certification Protocol
AS 4487-2013
Condensed
Aerosol Fire
Extinguishing Systems
Reference
42783209BA28F38F
CA257F5B00152E55

CERTIFICATES

FOR MARINE APPLICATIONS:

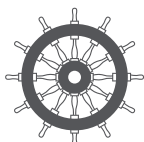

Organization
British Standards Institution
Description
Wheel Mark in Compliance with MED 2014/90/EU
Reference
BSI/A.1/3.46/560436 Module B & BSI/MED/PC/560437 Module D



Organization
ABS - American Bureau of Shipping
Certification Protocol
IMO MSC.1/Circ.1270 - UL 2775
Reference
Product Design Assessment
14-GE1148171-PDA



Organization
BV - Bureau Veritas
Certification Protocol
IMO MSC.1/Circ.1270
Reference
Type Approval Certificate 31670/A2 BV



Organization
RINA
Registro Italiano Navale
Certification Protocol
IMO MSC.1/Circ.1270
Reference
Type Approval Certificate FPE291612CS



Organization
RS - Russian Maritime Register of Shipping
Certification Protocol
IMO MSC.1/Circ.1270
Reference
Type Approval Certificate 16.00094.279



Organization
European Certification Bureau B.V.
Reference
Certificate of Compliance No. 15031995



Organization
United Kingdom Maritime & Coastguard Agency
Reference
Certificate of Inspection & Test MS 22/3/910



Organization
Australian Marine Safety
Reference
TE: AFP 07 09 23 ltr



Organization
Danish Maritime Authority
Reference
Type Approval Certificate 199925855



Organization
Hellenic Register of Shipping
Reference
4232/9



Organization
Netherlands Shipping Inspectorate
Reference
IVW-06KU00014



Organization
Icelandic Maritime Administration
Reference
506.001.02



Organization
Swedish Maritime Administration
Reference
070202-04-15563



Organization
Norwegian Maritime Authority
Reference
200416148-9/556



Organization
New Zealand Register of Ships
Reference
CSM 07020-03

“FirePro’s complete system solutions, bespoke service and superior quality provide a measurable advantage.”

Our systems are trusted by **industry leaders** around the world

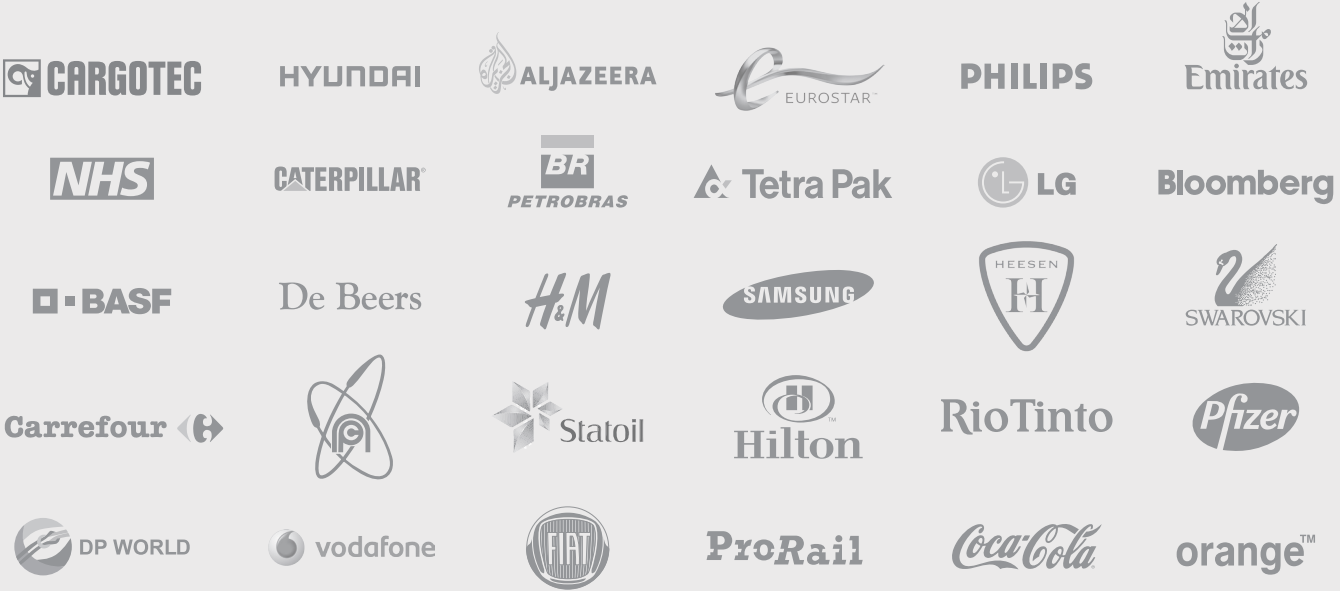



Global Network

We are proud to present a Global Distribution Network of selected Partners that we like to call family. Our Partners have the technical expertise and resources to serve each geographic area of responsibility with speed, quality and effectiveness.

EUROPE

Albania
 Belgium
 Bulgaria
 Croatia
 Cyprus
 Czech Republic
 Denmark
 Estonia
 Finland
 France
 Greece
 Hungary
 Iceland
 Ireland
 Italy
 Kosovo
 Luxembourg
 Malta
 Netherlands
 Norway
 Poland
 Portugal
 Romania
 Serbia
 Spain
 Sweden
 Switzerland
 Turkey
 United Kingdom

AMERICAS

Argentina
 Brazil
 Canada
 Chile
 Colombia
 Mexico
 Peru
 Uruguay
 U.S.A.

GULF & MIDDLE EAST

Bahrain
 Iran
 Iraq
 Jordan
 Saudi Arabia
 Lebanon
 Oman
 Qatar
 Syria
 UAE

ASIA & OCEANIA

Australia
 Bangladesh
 Georgia
 Hong Kong
 India
 Indonesia
 Malaysia
 New Zealand
 Philippines
 Singapore
 South Korea
 Taiwan
 Thailand
 Vietnam

AFRICA

Egypt
 Kenya
 Morocco
 Nigeria
 South Africa
 Sudan
 Tunisia

6 Koumandarias Str. Tonia Court, 6th Floor
 PO Box 54080, 3720 Limassol, CY Europe
 Tel.: +357 25 379 999 mail@firepro.com
www.firepro.com

LIMITED PRODUCT WARRANTY

FirePro Systems Limited ("FirePro Systems") hereby certify that all FirePro Condensed Aerosol Fire Extinguishing Units ("FirePro Condensed Aerosol Units") are built to rigorous engineering and manufacturing standards, are rigorously inspected and are covered by a three (3) year, from the date of purchase, warranty, to be free from defects in material and workmanship and a five (5) year, from the date of purchase, warranty, to be fit for purpose.

The warranty does not cover defects resulting from modification, alteration or misuse and exposure to corrosive conditions or exceptionally high temperatures.

The warranty is valid provided that the Condensed Aerosol Units have been installed by a suitably trained and authorized technician in accordance with the Use Manual and the Customer records verify that the Condensed Aerosol Units have been serviced and maintained in accordance with the Use Manual.

PRODUCT DISCLAIMERS

Except as provided above FirePro Systems makes no representations or warranties of any kind, whether express or implied, for the FirePro Condensed Aerosol Fire Extinguishing Systems, including but not limited to warranties of merchantability, fitness for a particular purpose, of title, or of non-infringement of third party rights, including the intellectual property rights of others.

This warranty is in lieu of and FirePro Systems expressly disclaims all other warranties, express or implied, including but not limited to fitness for a particular purpose and merchantability

LIMITATION OF LIABILITY

In no event, regardless of cause, FirePro Systems shall be liable for any indirect, special, incidental, punitive or consequential damages of any kind, whether arising under breach of contract, tort (including negligence), strict liability or otherwise, even if advised of the possibility of such damages.

NOTE TO READER

This Technical Prospectus is a point of reference for FirePro partners and industry associates. It provides an overview of our technology, its advantages and capabilities, as well as several technical parameters and specifications. For more detailed information on any of the FirePro products and/or the FirePro system components refer to the specific Technical Manual.

